

PROFILO INCASSO

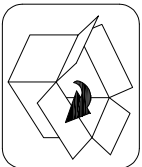

CE

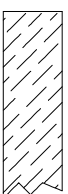
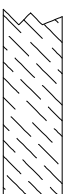
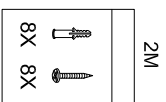
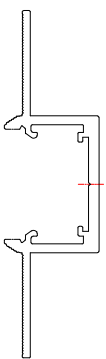

TAGLIO
L: 19mm x H > 14mm

1

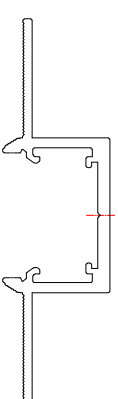
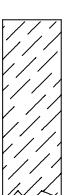
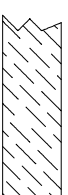

2

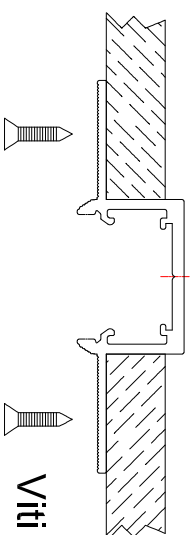

3

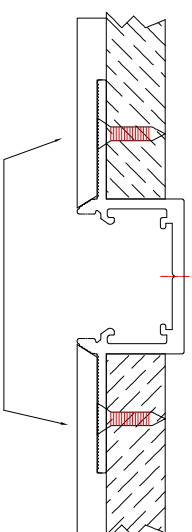

4



PER CONNESSIONI VEDERE DA FIGURA 13 A 5

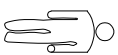
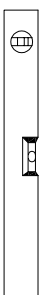
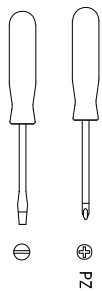
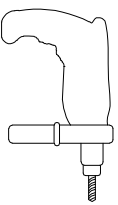
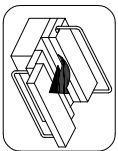

PROFILO ESTERNO

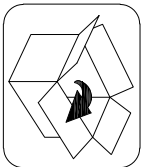

CE

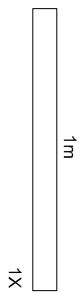

1x

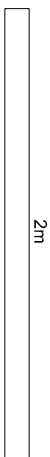

2m

2x 2x

4x 4x

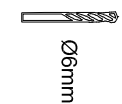

Ø6mm

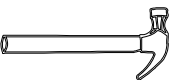
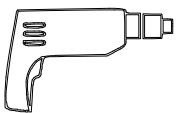
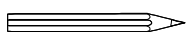
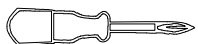

NON Incluso / Not included

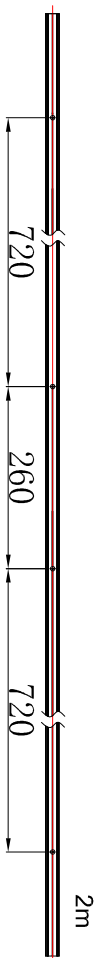
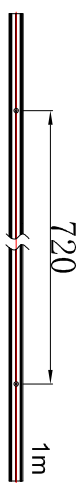

2m

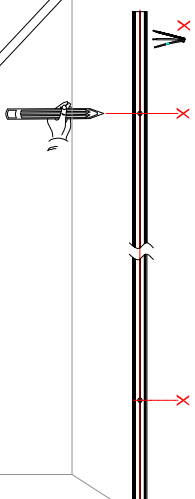

1

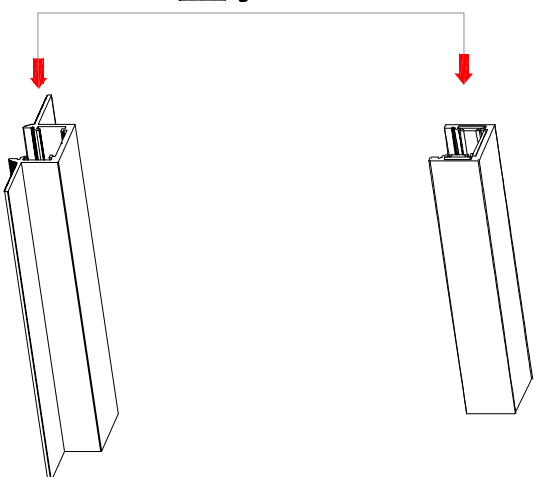
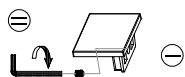
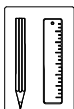

5

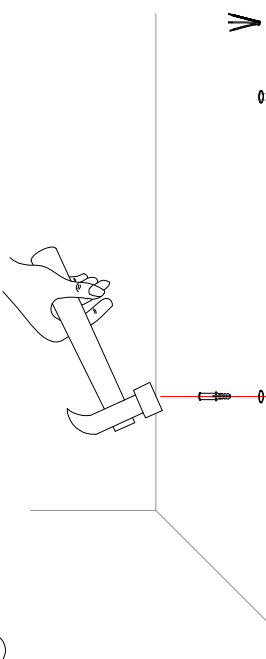

3

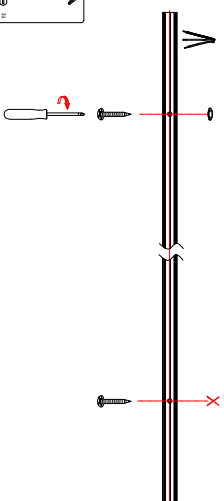

4

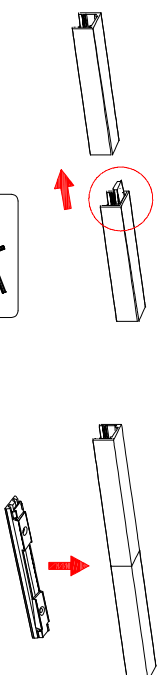

X1

6

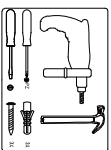

8

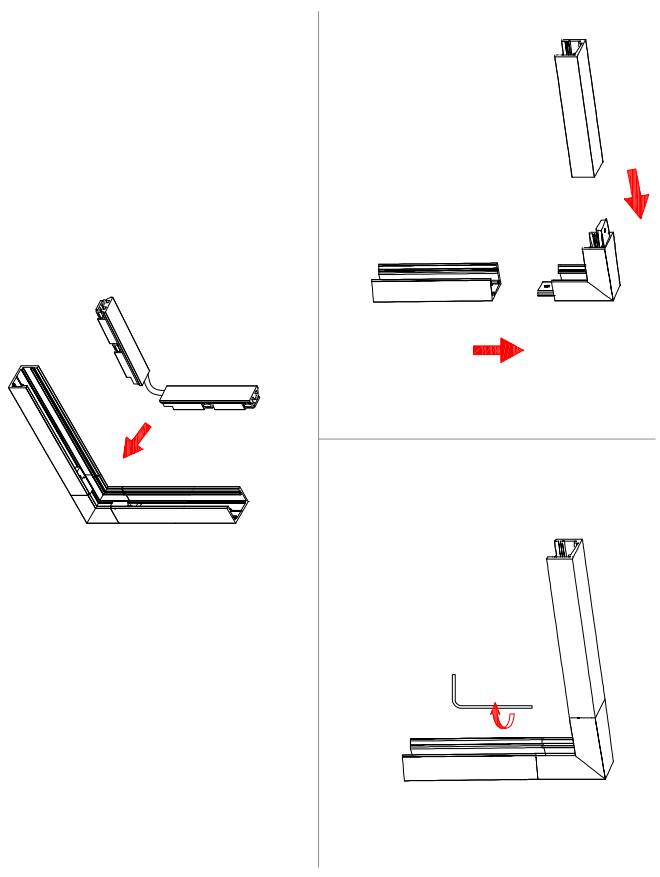

7

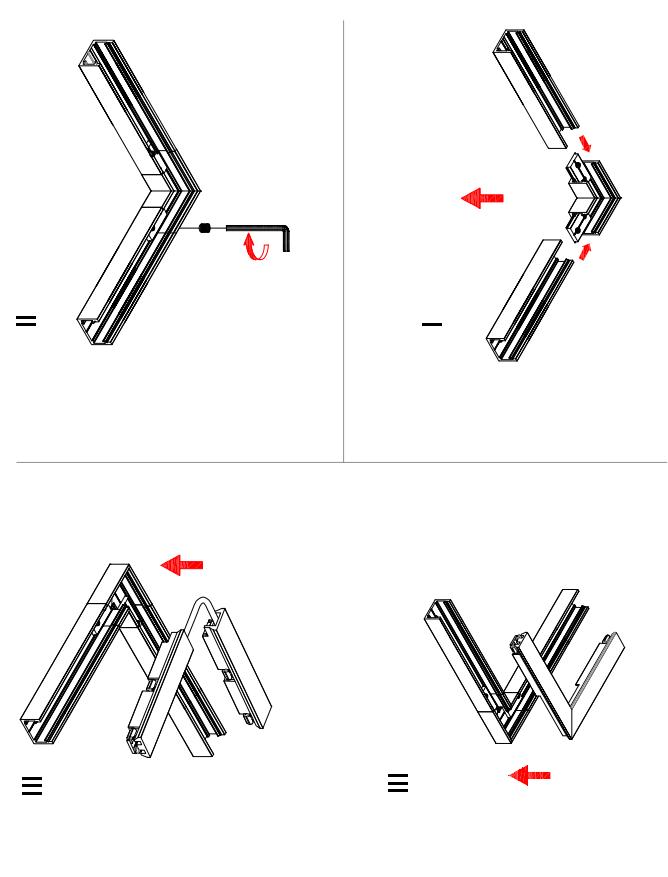

6

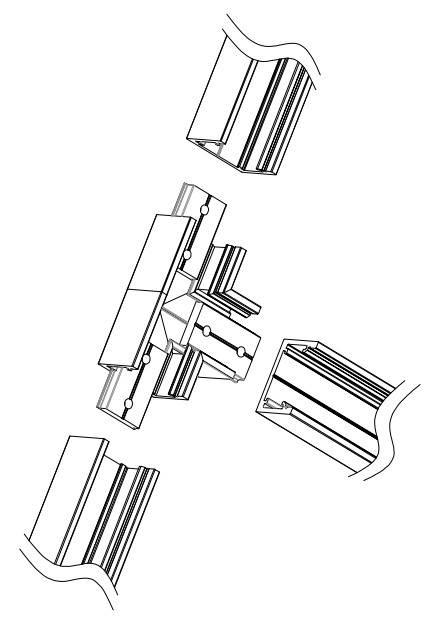
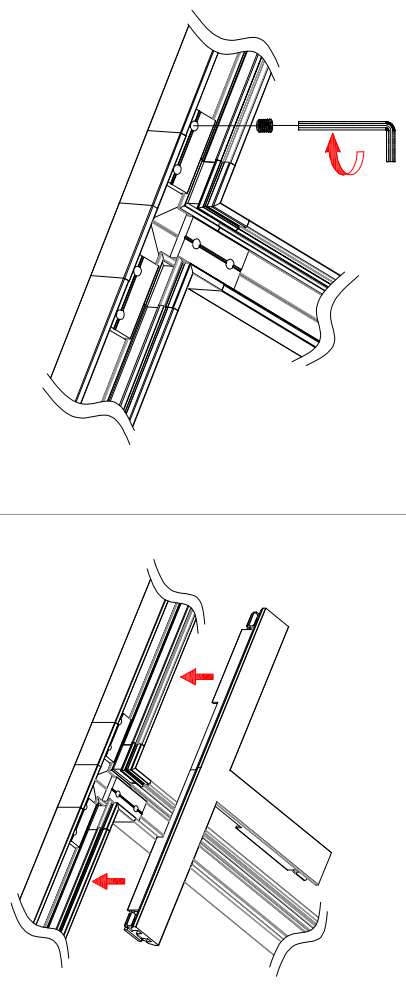

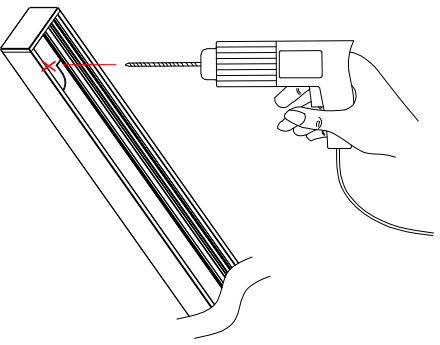

10

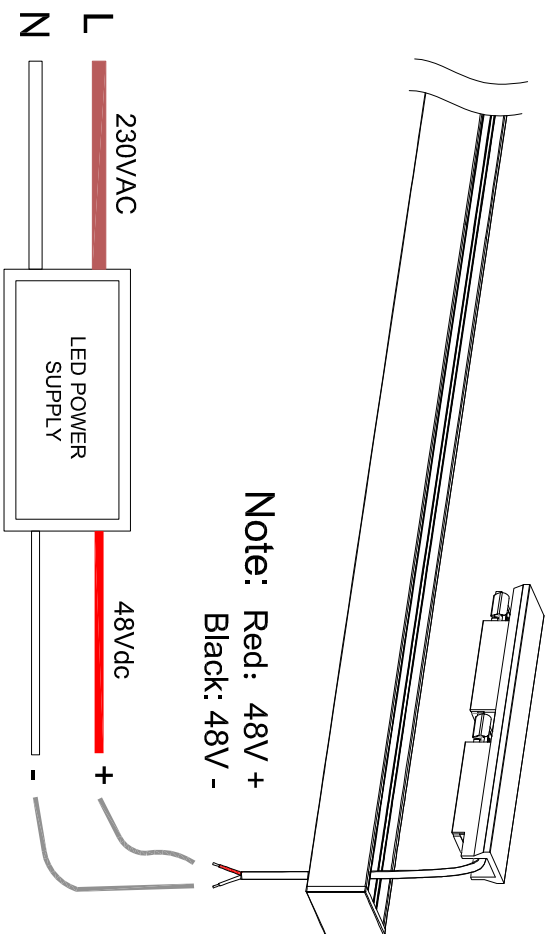

11



A

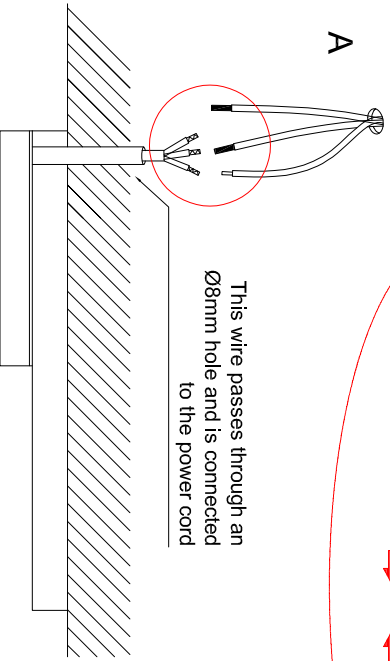

This wire passes through an Ø8mm hole and is connected to the power cord

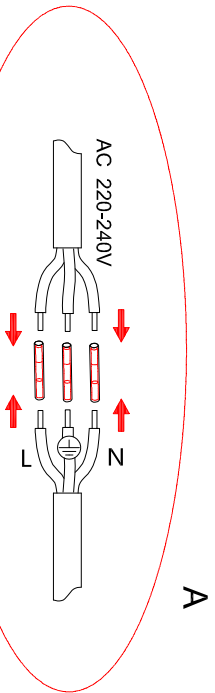

A

12

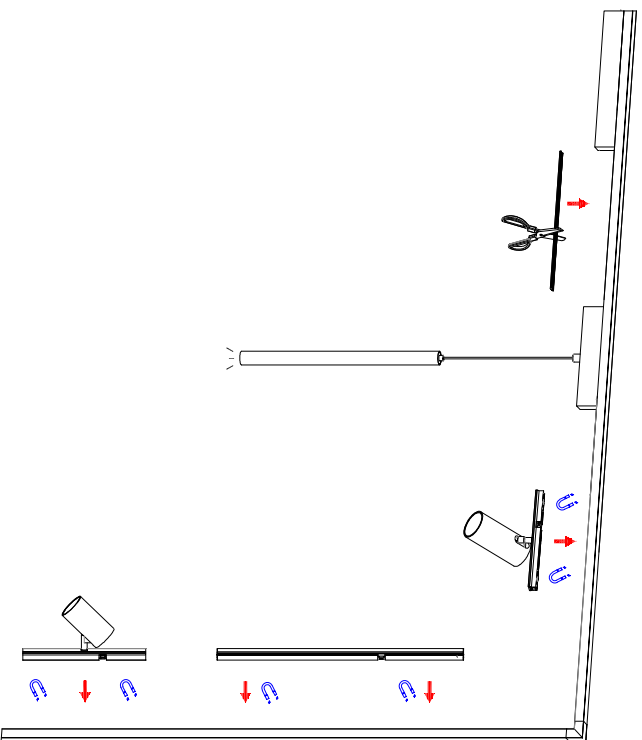
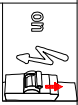

13