

Sicurezza

Security

IT - Prima dell'installazione dell'apparecchio disinserire l'energia elettrica.
Il presente apparecchio deve essere installato da persone qualificate.

EN - Before installation, disconnect energy. This device must be installed by qualified personnel.

Smaltimento e fine vita

Il simbolo del cassonetto barrato indica che questo prodotto non deve essere smaltito con i rifiuti urbani misti. A fine vita l'apparecchiatura deve essere conferita presso i centri di raccolta separata per rifiuti di apparecchiature elettriche ed elettroniche (RAEE) oppure riconsegnata al rivenditore in caso di acquisto di una nuova apparecchiatura equivalente.

Il corretto smaltimento contribuisce a prevenire possibili effetti negativi sull'ambiente e sulla salute umana e permette il recupero dei materiali di cui il prodotto è composto. L'utente ha la responsabilità di conferire il prodotto a fine vita presso gli idonei sistemi di raccolta, in conformità alla normativa vigente.



Ogni materiale richiede specifici accessori di fissaggio. Utilizzare viti e tasselli idonei al materiale a cui vanno fissati. Quelli inclusi potrebbero essere non idonei.

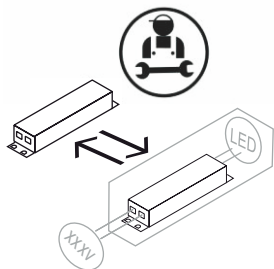

Driver sostituibile da un elettricista qualificato.
Replaceable control gear by a professional.

Guerra Lampadari s.a.s.
Via E. Mattei 20 – CAP 30020 Marcon (VE) – Italia
Mail: info@guerralampadari.it

MODEL
LAP905

Guerra Lampadari

Istruzioni di montaggio
Assembly instructions

Specifiche Tecniche Technical Data

Sorgente
Lamps

LED 25W
3000K

Alimentazione
Power supply

220-240V

Grado di protezione
Level of Protection

IP20

Simboli Symbol



**Questo prodotto contiene una
sorgente luminosa di classe**

This product contains a class light source

F



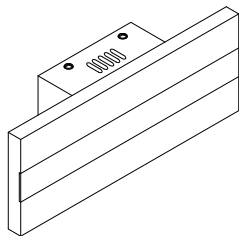
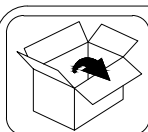

(A)

3X



(B)

3X

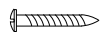

(C)

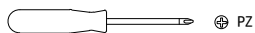
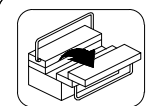

PZ

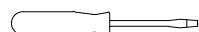

⊖

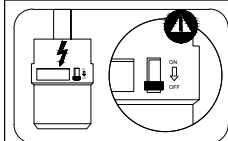
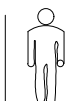
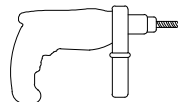

(A)

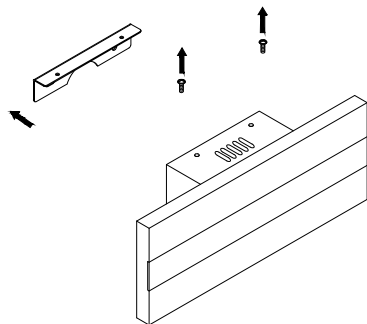

1

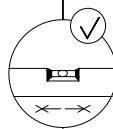
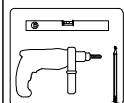

2

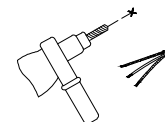
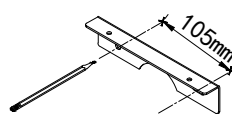

3



4

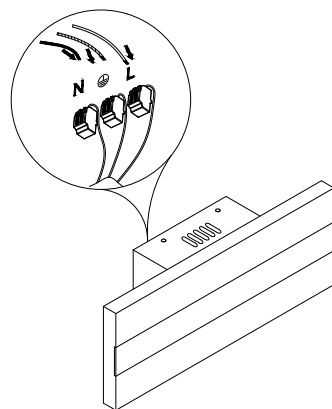
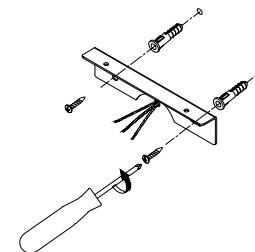

5

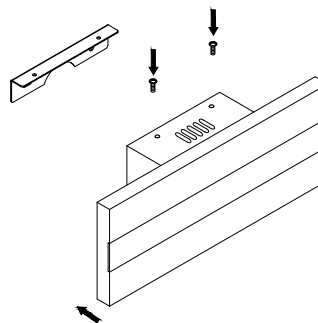

6

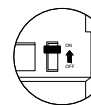

7

